

213860-1 ✓ ACTIVE

AMP | AMP CPC

TE Internal #: 213860-1

Circular Power Connectors, Housing, 600 VDC, Wire-to-Wire, 37 Position, Wire & Cable, Receptacle, Pin, Power & Signal, Black, All Plastic, AMP CPC

[View on TE.com >](#)



Connectors > Power Connectors > Circular Power > Circular Power Connectors > Cable/Panel Mount Connector, CPC Series 1



Connector Product Type: **Housing**

Operating Voltage: **600 VDC**

Connector System: **Wire-to-Wire**

Number of Positions: **37**

Sealable: **No**

[All Cable/Panel Mount Connector, CPC Series 1 \(57\)](#)

Features

Product Type Features

Connector Product Type	Housing
Connector System	Wire-to-Wire
Sealable	No
Connector & Contact Terminates To	Wire & Cable
Connector & Housing Type	Receptacle
Circular Connector Shell Type	All Plastic

Configuration Features

Reverse Numbering	With
Number of Positions	37
Number of Power Positions	0
Keying	B
Number of Signal Positions	37



Electrical Characteristics

Operating Voltage	600 VAC
-------------------	---------

Contact Features

Reverse Gender	No
Contact Type	Pin
Contact Protection	With

Mechanical Attachment

Panel Mount Feature Type	Flange with Mounting Holes
Screw & Hole Thread Size	1-3/8 - 18 UNEF-2A
Connector Mounting Type	Panel Mount
Mating Alignment	With
Mating Retention	With
Panel Mount Feature	With
Mating Alignment Type	Keyed
Mating Retention Type	Threaded Coupling

Housing Features

Body Orientation	Straight
Housing Color	Black
Housing Material	Nylon, Thermoplastic
Circular Connector Shell Size	23

Usage Conditions

Operating Temperature Range	-55 – 105 °C[-67 – 221 °F]
Fluid Resistance	None

Operation/Application

Circuit Application	Power & Signal
Shielded	No

Industry Standards

UL Flammability Rating	UL 94V-0
VDE Tested	No

Packaging Features

Packaging Method	Package
Packaging Quantity	1

Other

Comment

4 Locating Key Arrangement.

Product Compliance

[For compliance documentation, visit the product page on TE.com>](#)

EU RoHS Directive 2011/65/EU

Compliant

EU ELV Directive 2000/53/EC

Compliant

China RoHS 2 Directive MIIT Order No 32, 2016

No Restricted Materials Above Threshold

EU REACH Regulation (EC) No. 1907/2006

Current ECHA Candidate List: JUNE 2022 (224)

Candidate List Declared Against: JUNE 2022 (224)

Does not contain REACH SVHC

Halogen Content

BFR/CFR/PVC Free, but Br/Cl >900 ppm in other sources.

Solder Process Capability

Not applicable for solder process capability

Product Compliance Disclaimer

This information is provided based on reasonable inquiry of our suppliers and represents our current actual knowledge based on the information they provided. This information is subject to change. The part numbers that TE has identified as EU RoHS compliant have a maximum concentration of 0.1% by weight in homogenous materials for lead, hexavalent chromium, mercury, PBB, PBDE, DBP, BBP, DEHP, DIBP, and 0.01% for cadmium, or qualify for an exemption to these limits as defined in the Annexes of Directive 2011/65/EU (RoHS2). Finished electrical and electronic equipment products will be CE marked as required by Directive 2011/65/EU. Components may not be CE marked. Additionally, the part numbers that TE has identified as EU ELV compliant have a maximum concentration of 0.1% by weight in homogenous materials for lead, hexavalent chromium, and mercury, and 0.01% for cadmium, or qualify for an exemption to these limits as defined in the Annexes of Directive 2000/53/EC (ELV). Regarding the REACH Regulation, the information TE provides on SVHC in articles for this part number is based on the latest European Chemicals Agency (ECHA) 'Guidance on requirements for substances in articles' posted at this URL: <https://echa.europa.eu/guidance-documents/guidance-on-reach>

Compatible Parts

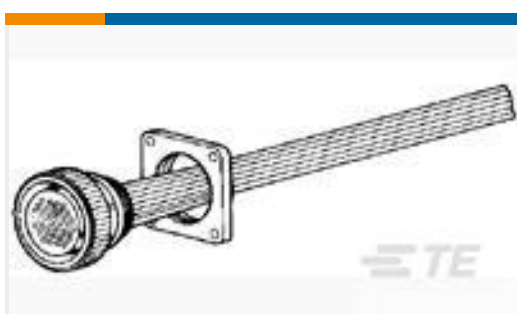

TE Part # 207299-4
FLANGE PLUG



TE Part # 213848-1
CPC PLUG ASSEMBLY SIZE 23-37



TE Part # CAT-AM71-C83998B
CPC Cable Clamps



TE Part # 6-2407269-4
CAP, CPC, SIZE 23 RECP, YELLOW



Also in the Series | AMP CPC

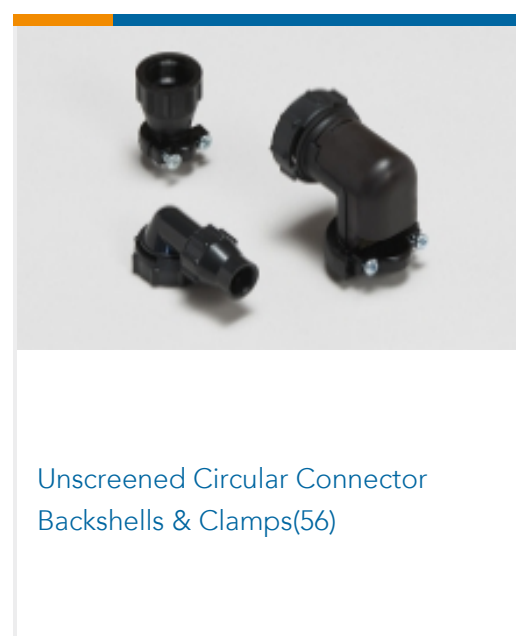
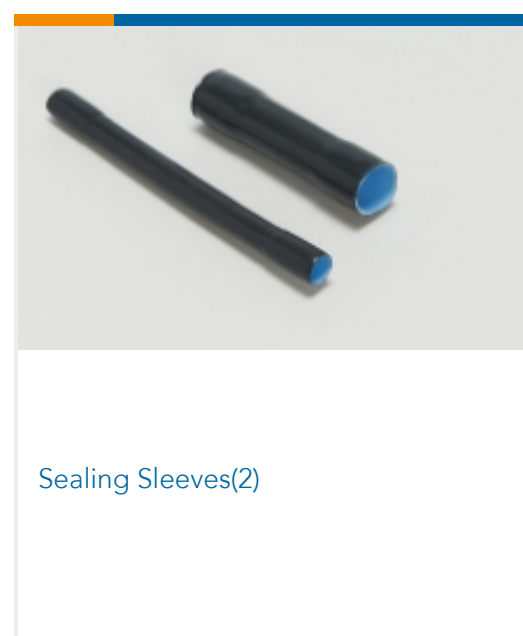
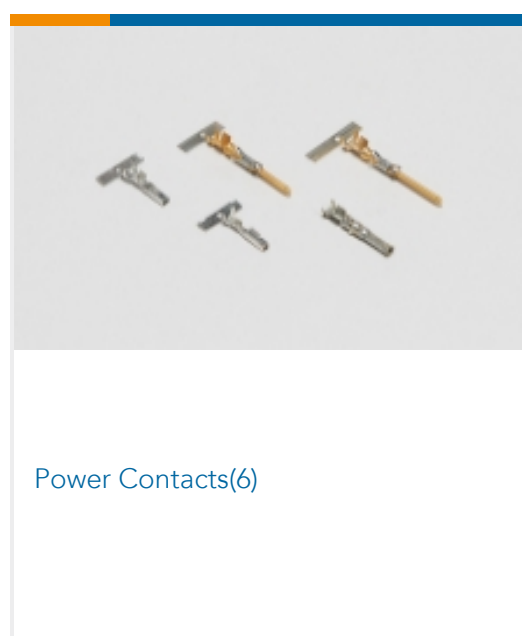
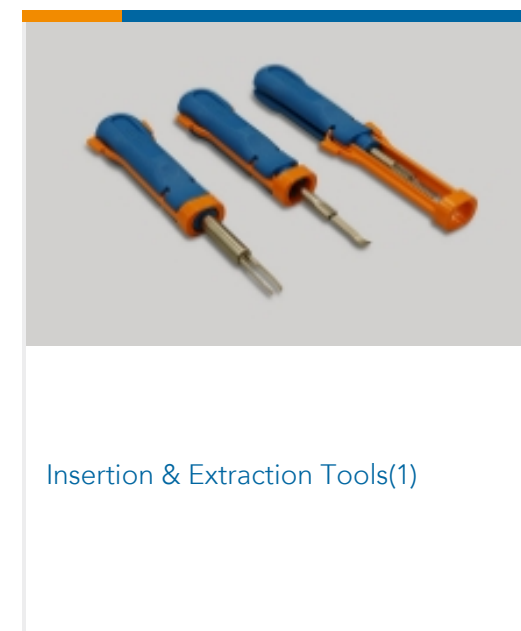
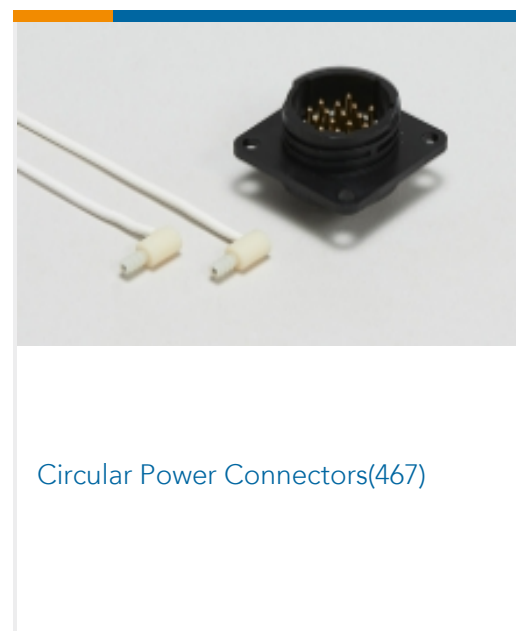
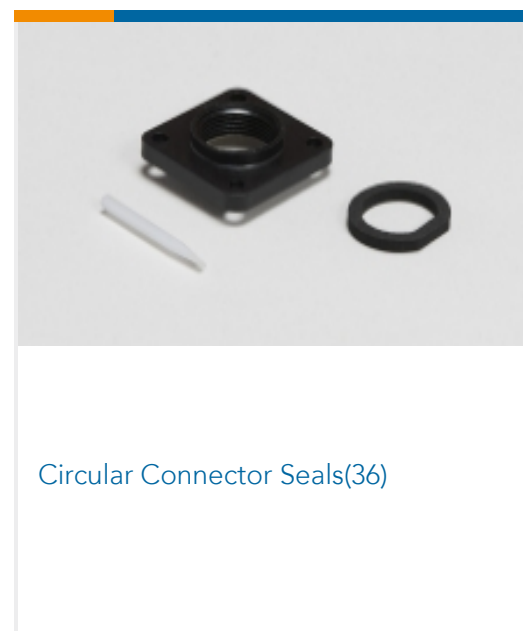
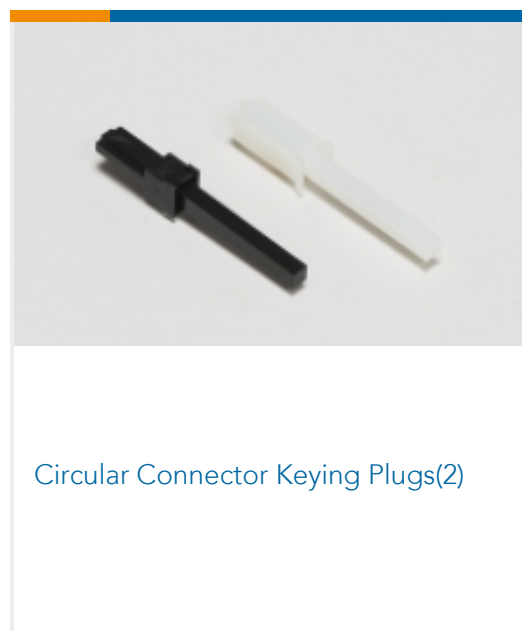
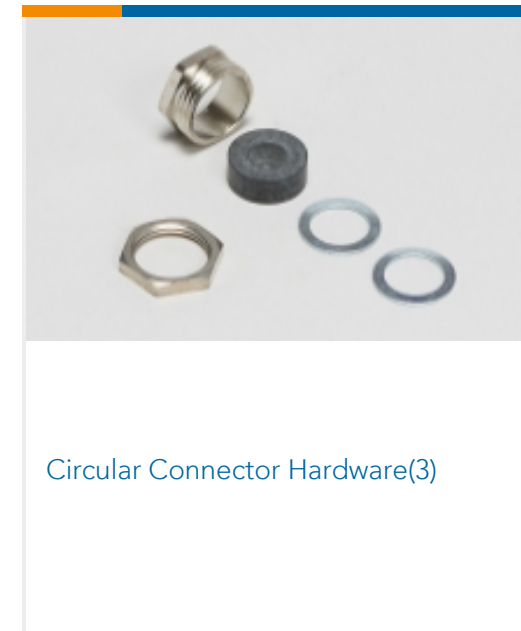
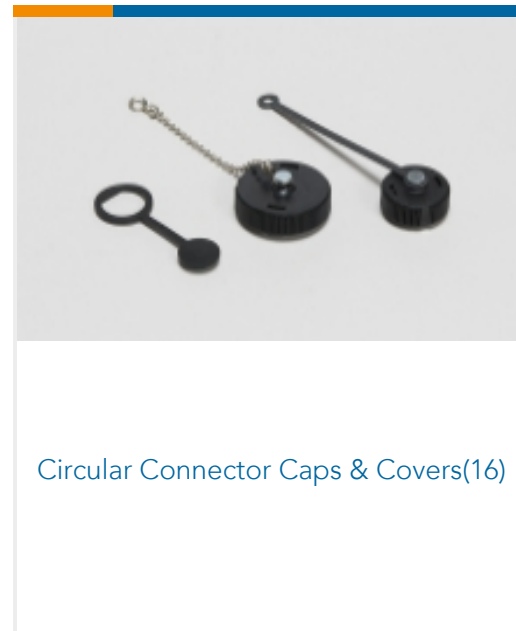
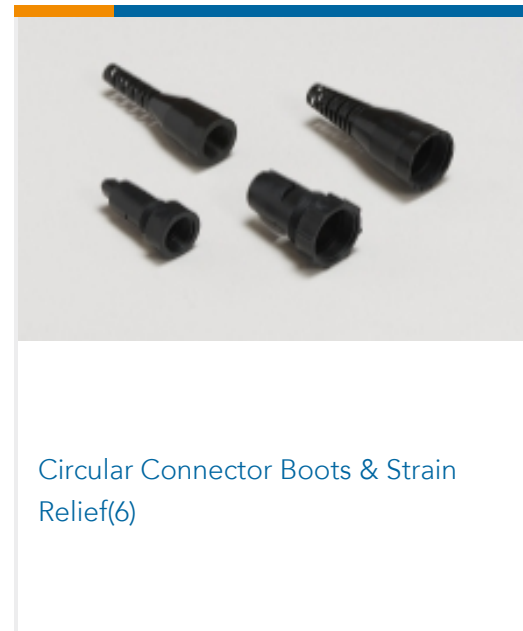
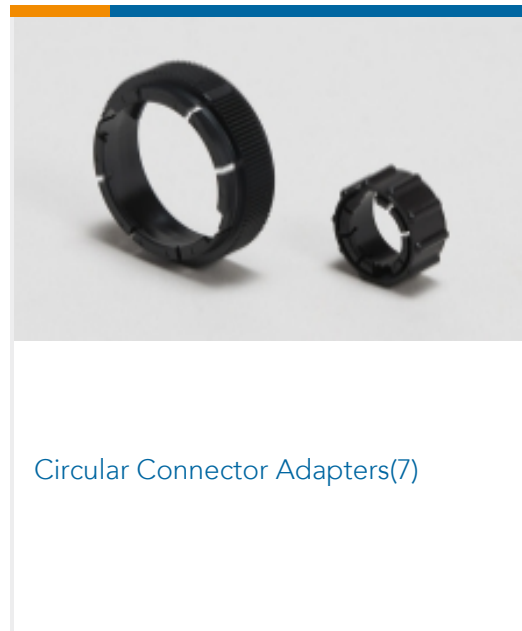

Documents

Product Drawings

23-37 RCPT HSG,STD SEX,CPC

English

CAD Files

Customer View Model

ENG_CVM_CVM_213860-1_F.2d_dxf.zip

English



3D PDF

3D

Customer View Model

[ENG_CVM_CVM_213860-1_F.3d_igs.zip](#)

English

Customer View Model

[ENG_CVM_CVM_213860-1_F.3d_stp.zip](#)

English

By downloading the CAD file I accept and agree to the [Terms and Conditions](#) of use.

Datasheets & Catalog Pages

[AMP Circular Connectors for Commercial Signal & Power Applications](#)

English

Product Specifications

[Application Specification](#)

English

Agency Approvals

[UL Report](#)

English